

FRONT ELEVATION

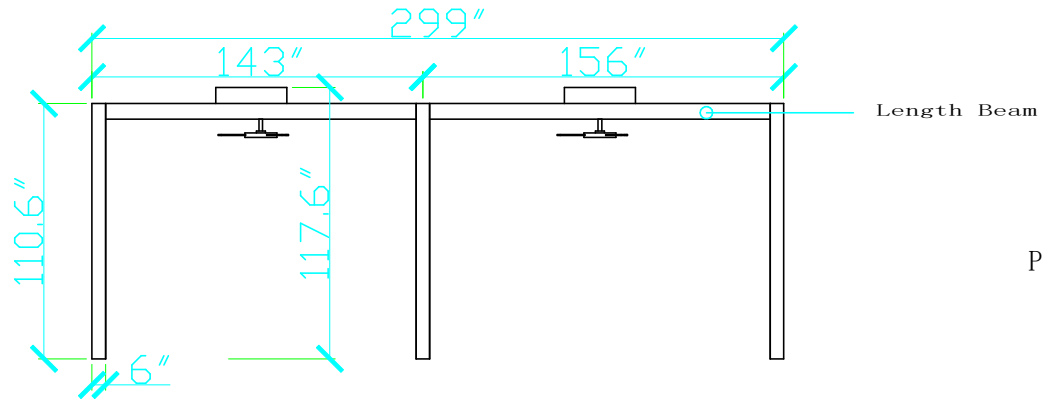

SIDE ELEVATION

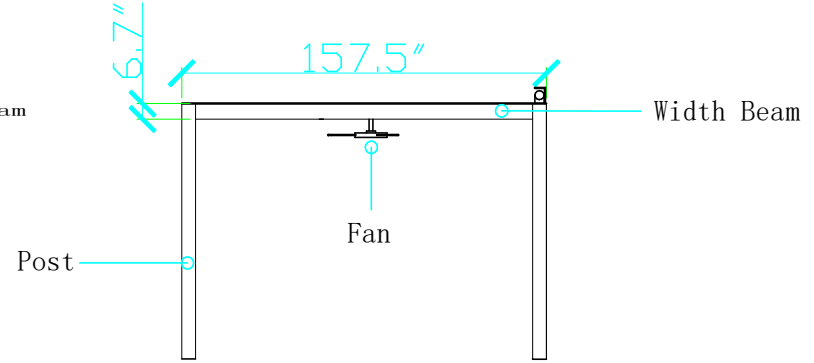

PLAN VIEW

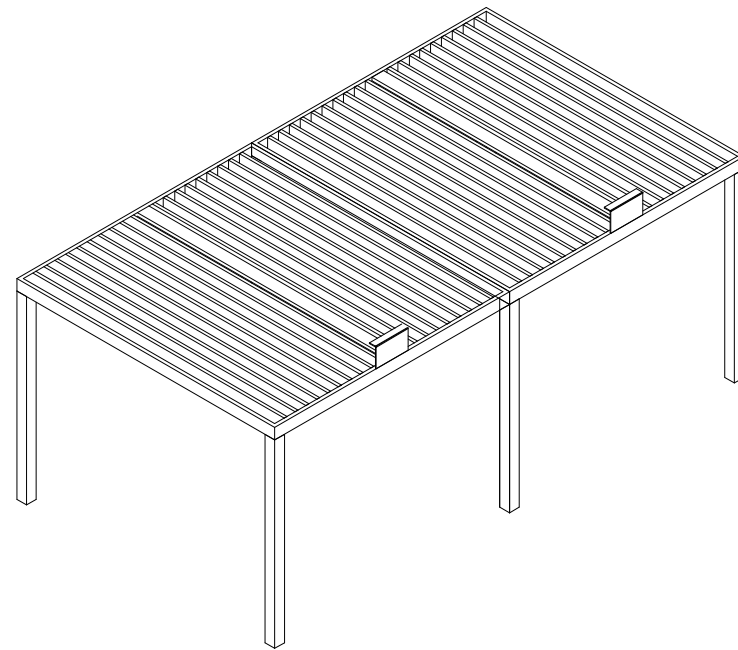

Kit Components

Description	Quantity
6"x6" Post	6
7.9"x2" Width Beam	2
7.9"x2" Length Beam	4
52" Fan	2
Solar Panel Middle Beam	3
DC 24V Motor	2
Louvers	42
LED Lights	7

