

FRONT ELEVATION

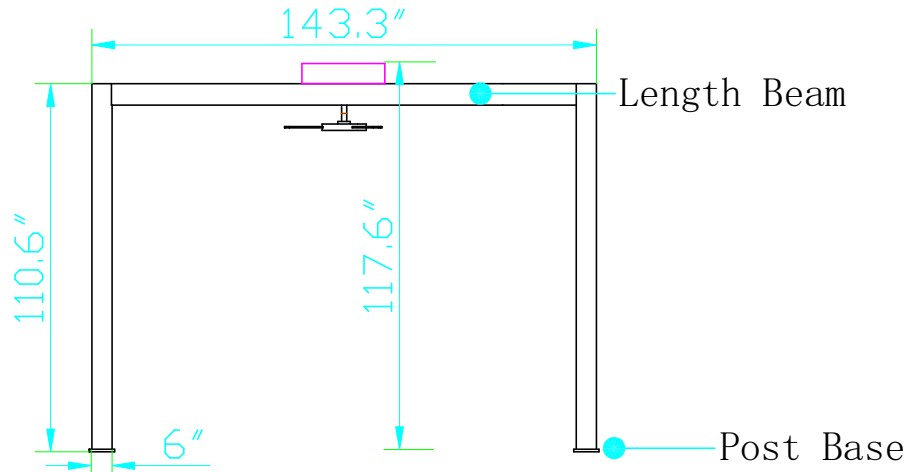

SIDE ELEVATION

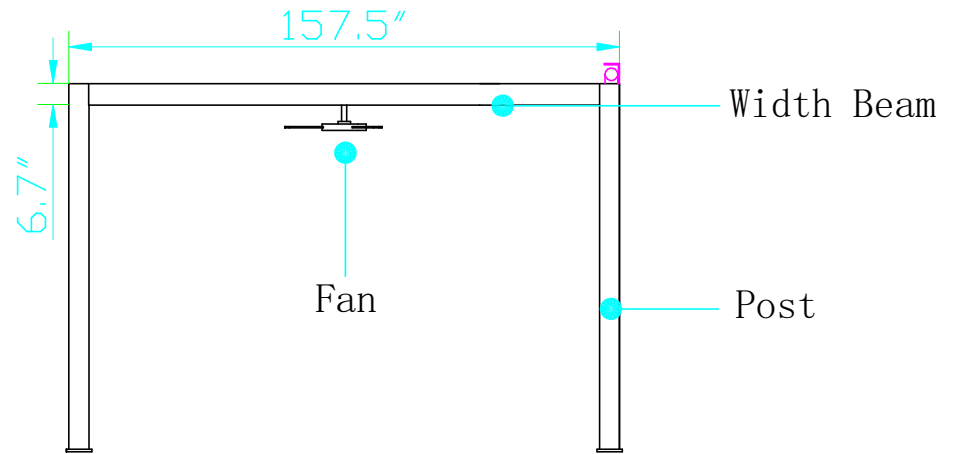

PLAN VIEW

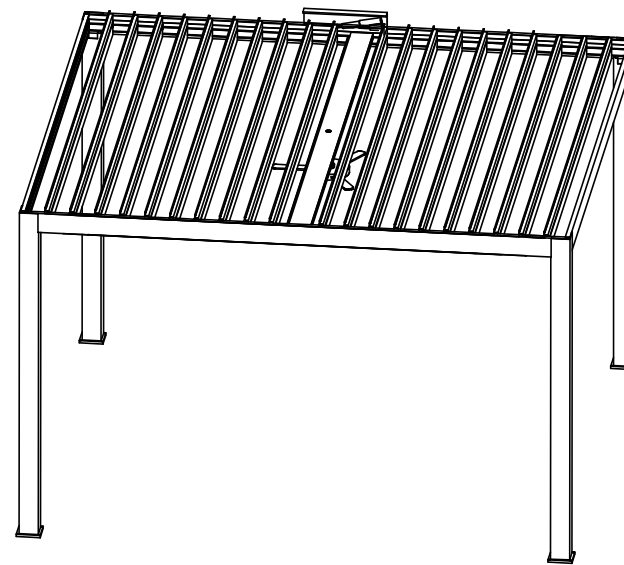
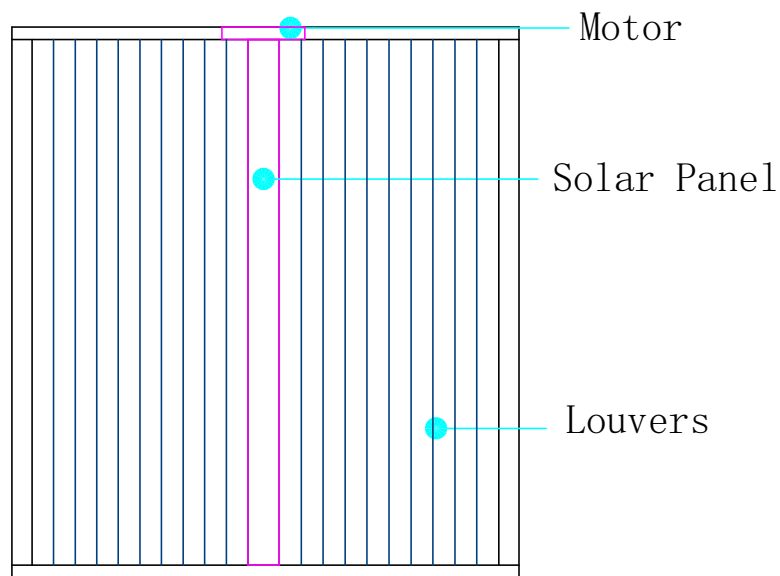

Kit Components

Description	Quantity
6"x6" Post	4
7"x2" Width Beam	2
7"x2" Length Beam	2
52" Fan	1
Solar Panel Middle Beam	1
DC 24V Motor	1
Louvers	20
LED Lights	2